

Varenummer: 20070511
 Beskrivelse: E+G Aksial kugleled
 GN 782-M10-KS-1

Mål

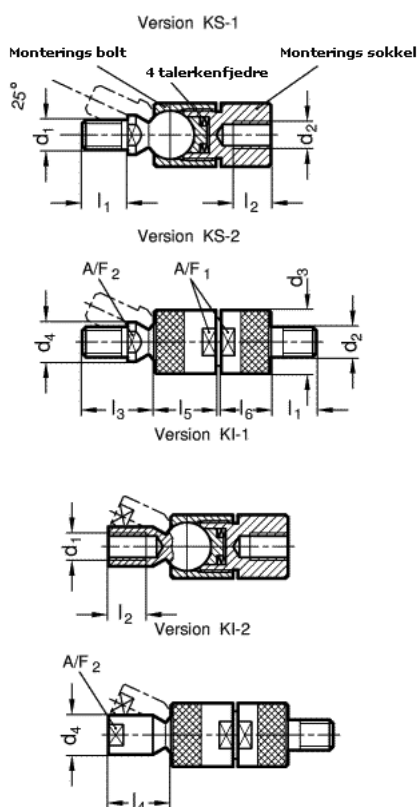

$d_1 = M 10$	$l_5 = 21.0$
$d_2 = M 10$	$l_6 = 17$
$d_3 = 21$	$sw1 = 19$
$d_4 = 13$	$sw2 = 11$
$l_1 = 15$	
$l_2 = 12$	
$l_3 = 23.5$	
$l_4 = 20.5$	